

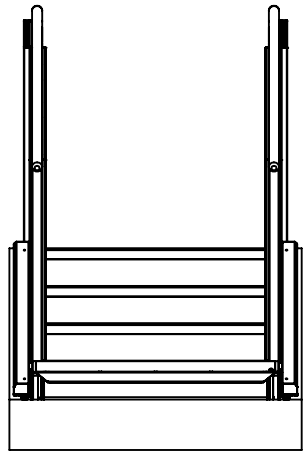

DETAIL A  
SCALE 1 : 10

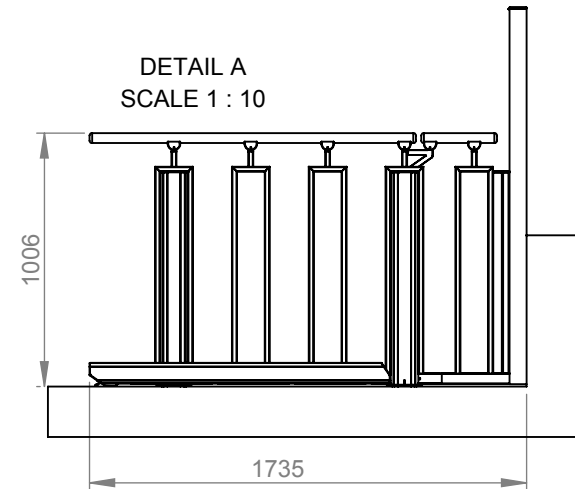

Minimum Installation Dimension  
 1006 mm (model 700 mm)  
 1106 mm (model 800 mm)  
 1206 mm (model 900 mm)  
 1306 mm (model 1000 mm)

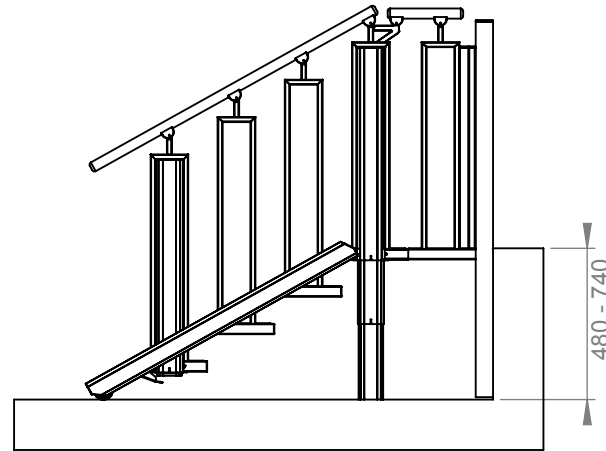

Specs.	Choice	Model:	4+1 STEPS		 Product Name <b>FLEXSTEP V2</b>
Installation	Indoor	Balustrade:	Square	Last change date: 28-10-2015	
Handrails	Oak	Lifting Capacity:	400 kg	Customer :	Scale: 1:30 A4
Step Inserts	Oak	Drawn by:	MP		
Colour	Akzo Nobel 900				
Packing	Carton or Wood Pallet Box				
Op. Panel					

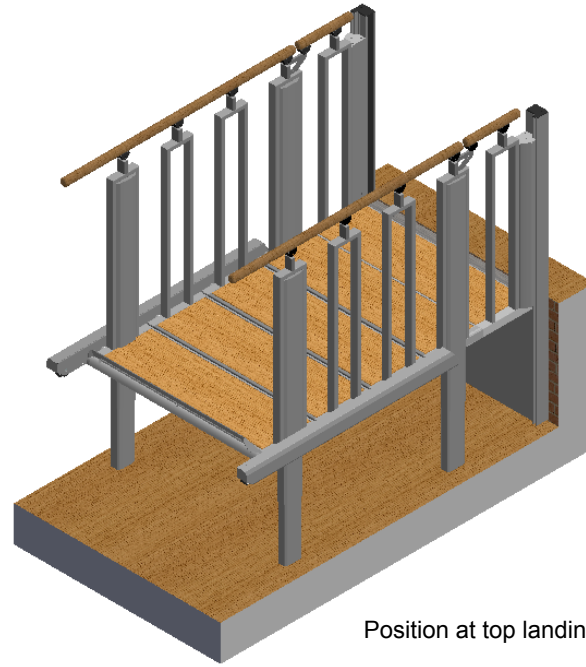

Position at top landing

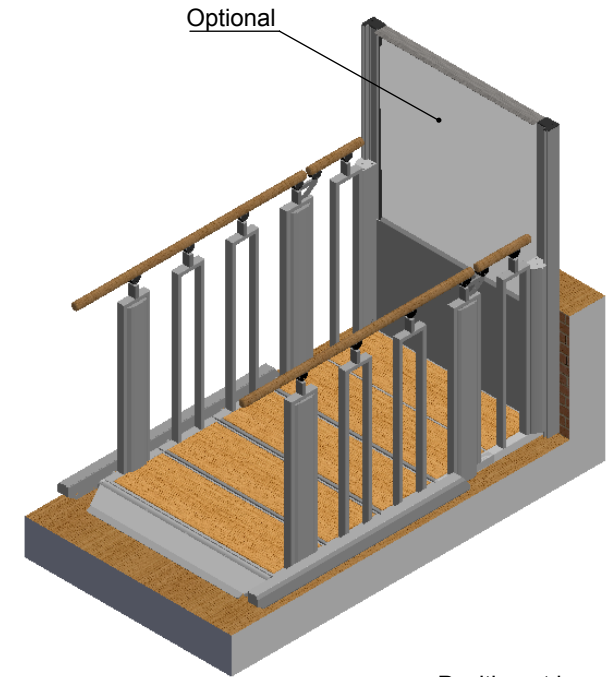

Position at lower landing

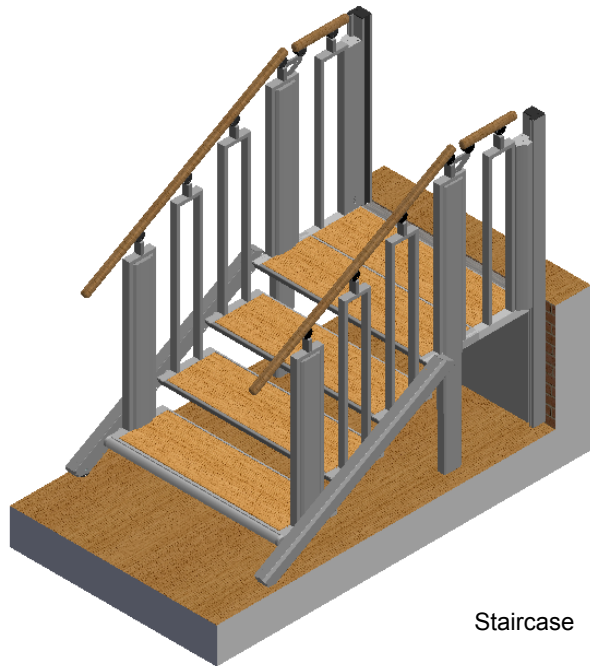

Staircase

Specs.	Choice	Model:	4+1 STEPS		
Installation	Indoor	Balustrade:	Square	Last change date:	
Handrails	Oak	Lifting Capacity:	400 kg	28-10-2015	FLEXSTEP V2
Step Inserts	Oak	Drawn by:	MP	Customer :	Scale:
Colour	Akzo Nobel 900				1:30
Packing	Carton or Wood Pallet Box				A4
Op. Panel					