

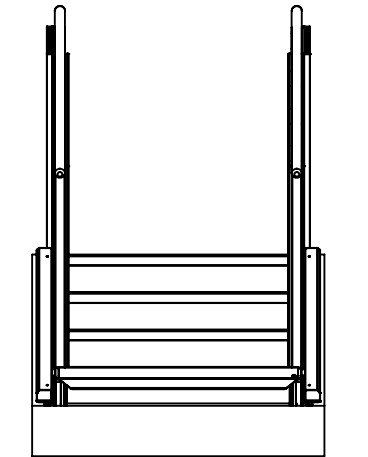

DETAIL A
SCALE 1 : 10

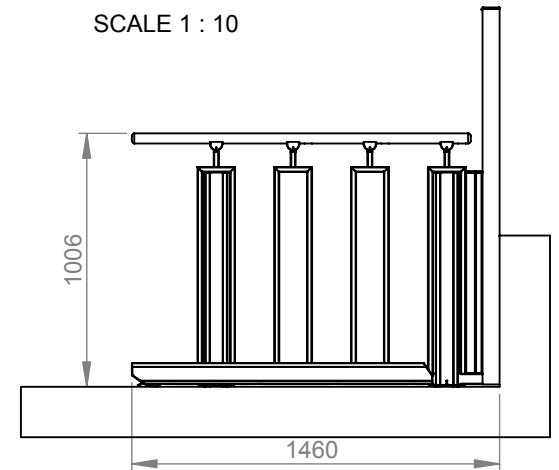
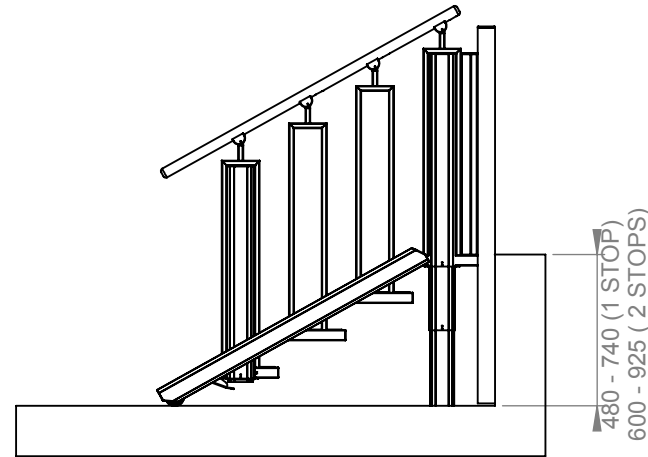

Minimum Installation Dimension
1006 mm (model 700 mm)
1106 mm (model 800 mm)
1206 mm (model 900 mm)
1306 mm (model 1000 mm)

Specs.	Choice	Model:	4 STEPS		 Product Name FLEXSTEP V2
Installation	Indoor	Balustrade:	Square	Last change date: 28-10-2015	
Handrails	Oak	Lifting Capacity:	400 kg	Customer :	Scale: 1:30 A4
Step Inserts	Oak	Drawn by:	MP		
Colour	Akzo Nobel 900				
Packing	Carton or Wood Pallet Box				
Op. Panel					

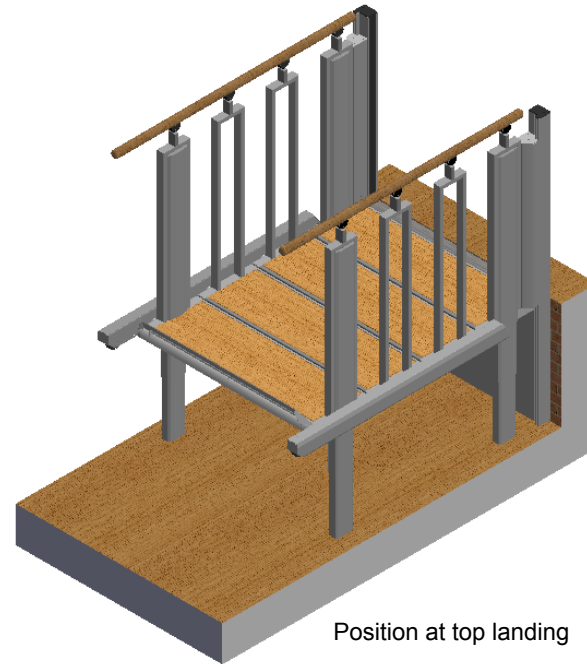

Position at top landing

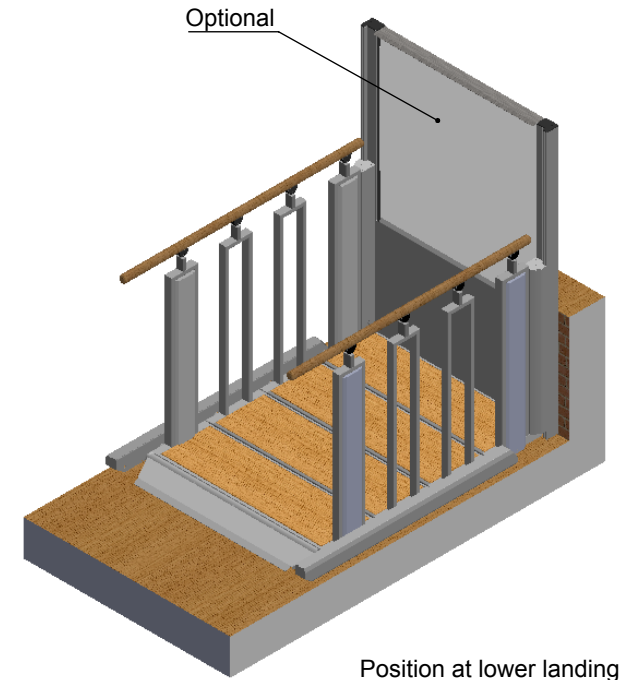

Position at lower landing

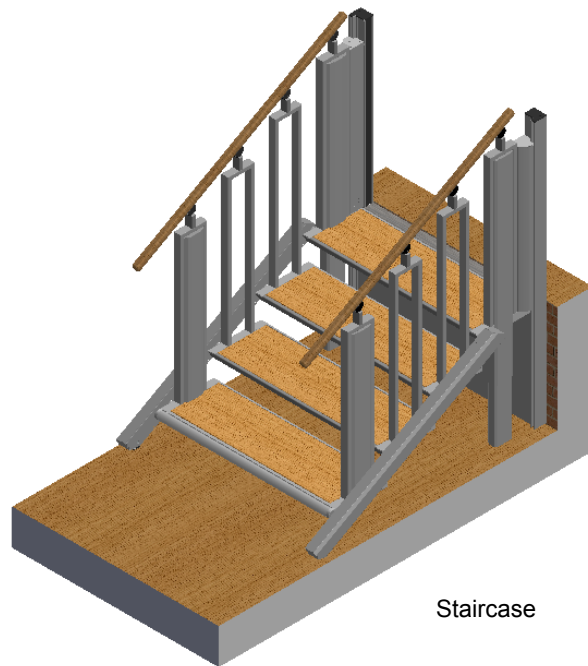

Staircase

Specs.	Choice	Model:	4 STEPS		
Installation	Indoor	Balustrade:	Square	Last change date:	
Handrails	Oak	Lifting Capacity:	400 kg	Customer :	
Step Inserts	Oak	Drawn by:	MP	Product Name	FLEXSTEP V2
Colour	Akzo Nobel 900			Scale:	1:30 A4
Packing	Carton or Wood Pallet Box				
Op. Panel					