

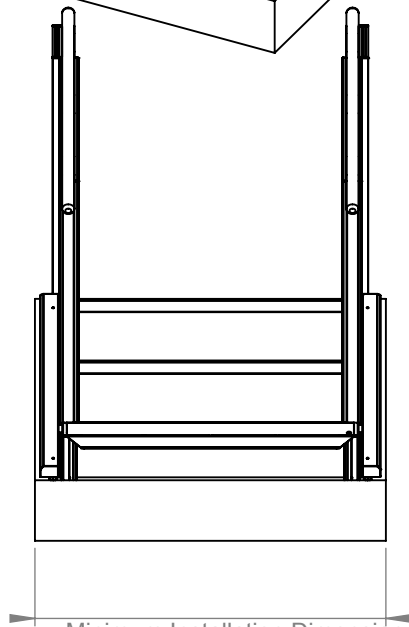

DETAIL A  
SCALE 1 : 10

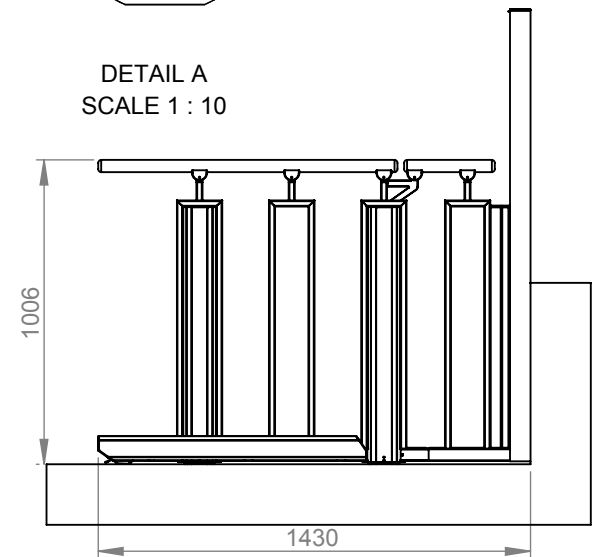

Minimum Installation Dimension  
 1006 mm (model 700 mm)  
 1106 mm (model 800 mm)  
 1206 mm (model 900 mm)  
 1306 mm (model 1000 mm)

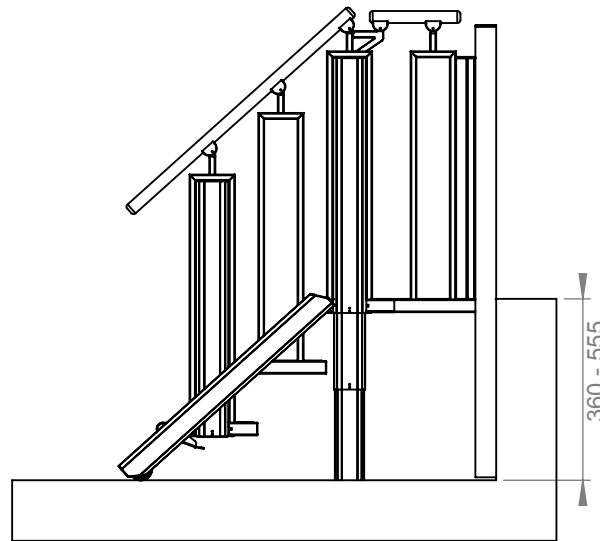

|              |                           |                   |           |                                 |   |
|--------------|---------------------------|-------------------|-----------|---------------------------------|---|
| Specs.       | Choice                    | Model:            | 3+1 STEPS |                                 | <br>Product Name<br><b>FLEXSTEP V2</b> |
| Installation | Indoor                    | Balustrade:       | Square    | Last change date:<br>28-10-2015 |   |
| Handrails    | Oak                       | Lifting Capacity: | 400 kg    | Customer :                      | Scale: 1:25 A4  |
| Step Inserts | Oak                       | Drawn by:         | MP        |                                 |   |
| Colour       | Akzo Nobel 900            |                   |           |                                 |   |
| Packing      | Carton or Wood Pallet Box |                   |           |                                 |   |
| Op. Panel    |                           |                   |           |                                 |   |

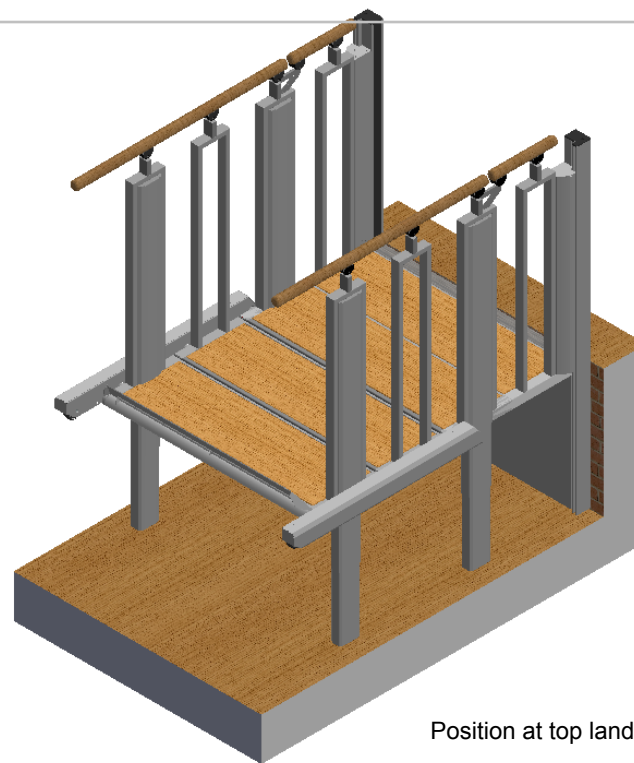

Position at top landing

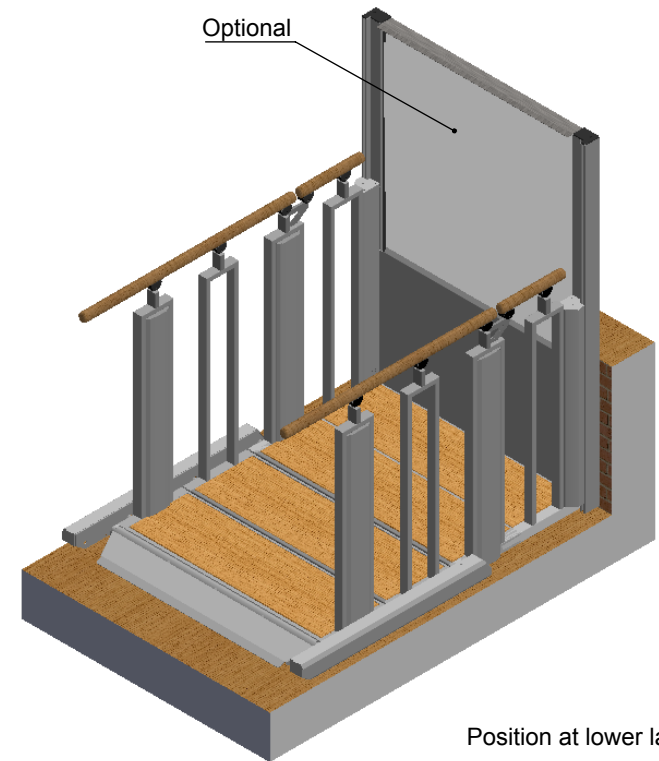

Position at lower landing

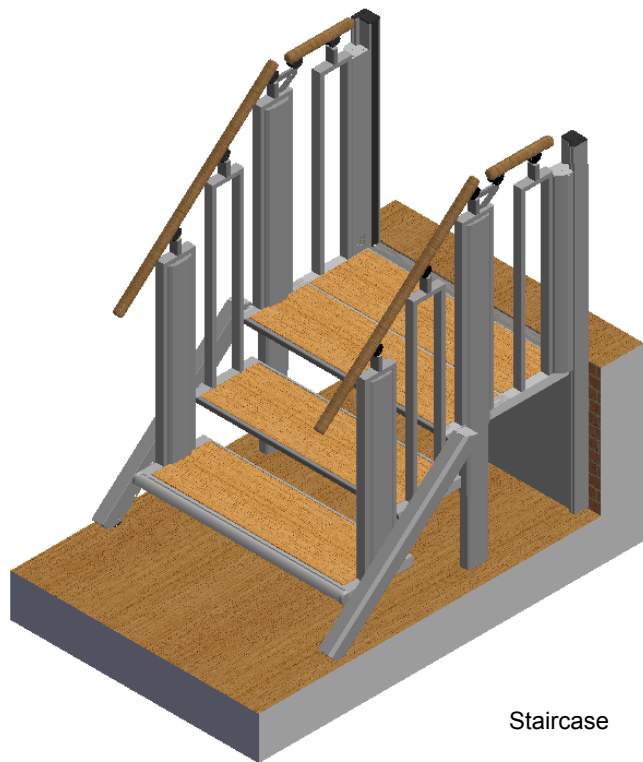

Staircase

|              |                           |                   |           |                   |   |
|--------------|---------------------------|-------------------|-----------|-------------------|---|
| Specs.       | Choice                    | Model:            | 3+1 STEPS |                   |  |
| Installation | Indoor                    | Balustrade:       | Square    | Last change date: |   |
| Handrails    | Oak                       | Lifting Capacity: | 400 kg    | Product Name      | FLEXSTEP V2   |
| Step Inserts | Oak                       | Drawn by:         | MP        | Customer :        | Scale: 1:25 A4  |
| Colour       | Akzo Nobel 900            |                   |           |                   |   |
| Packing      | Carton or Wood Pallet Box |                   |           |                   |   |
| Op. Panel    |                           |                   |           |                   |   |